

N 816 SERIES VACUUM PUMPS



N 816 KNE



N 816 KN.29 DC-B-M



N 816 KN.29 DC-B

ADVANTAGES

- High level of performance in a compact size
- Copes well with vapor and condensation
- High-performing - collecting containers are evacuated quickly and reliably

POSSIBLE AREAS OF USE

- Diagnostics – disposal of sample waste
- Medical technology – especially autoclaves
- Mobile/portable gas measurement technology
- Stationary emission measurement technology (CEMS)

Please visit our website
www.knf.com
to get more information

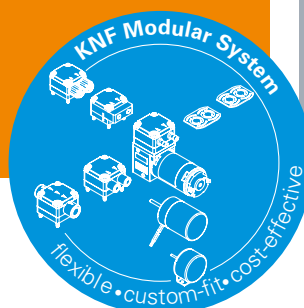

PERFORMANCE DATA

Series model	N 816							
Material design	KNE	KTE	KNDC-B	KTDC-B	KN.29 DC-B	KT.29 DC-B	KN.29 DC-B-M	KT.29 DC-B-M
Pump head	PPS							
Diaphragm	EPDM	PTFE-coated	EPDM	PTFE-coated	EPDM	PTFE-coated	EPDM	PTFE-coated
Valves	EPDM	FFPM	EPDM	FFPM	EPDM	FFPM	EPDM	FFPM
Flow rate at atm. pressure (l/min)	14.0	13.0	16.0	14.0	3.5–16.0	3.5–14.0	3.5–16.0	3.5–14.0
Ultimate vacuum (mbar abs.)	100	140	100	140	100	140	100	140
Max. operating pressure (bar rel./psig)	0.5/7.3							
Permissible ambient temperature (°C)	+5 ... +40							
Permissible media temperature (°C)	+5 ... +40							
Weight (kg/lbs)	1.8/4.0		1.6/3.5				1.1/2.4	

ELECTRICAL DATA

Voltage (V)	100	115 220	230	24					
Motor	Capacitor motor			Brushless DC motor		Brushless DC motor, control voltage: 0.1...5 V*		Brushless DC motor, PWM-signal: 20...100 %	
Protection class motor	IP 00			IP 20				IP 30	
Frequencies (Hz)	50/60	60	50	-					
Power P _i (W)	75.0/64.0		64.0 64.0	79.0	33.0			31.0	26.0
N 816 KNE	78.0/63.0		61.0 65.0	76.0					
N 816 KTE									
I _{max} (A)	0.90/0.70		0.60 0.35	0.45	1.4		1.3		1.1
N 816 KNE	1.00/0.70		0.60 0.35	0.50					
N 816 KTE									

* other control voltages on request

N 816 KNE | KTE

PERFORMANCE DATA

Series model	Flow rate at atm. pressure (l/min) ¹⁾	Max. operating pressure (bar rel./psig)	Ultimate vacuum (mbar abs.)
N 816 KNE	14.0	0.5/7.3	100
N 816 KTE	13.0	0.5/7.3	140

¹⁾ Liter at STP

N 816 K_E

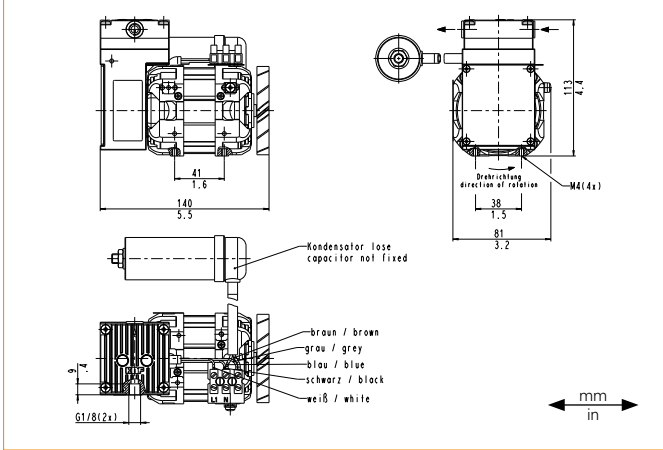

N 816 KNE

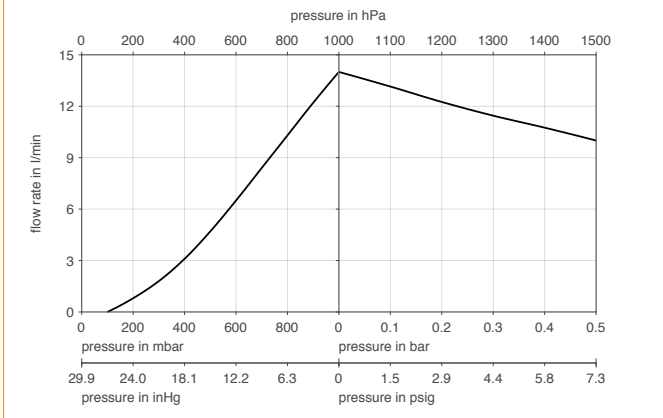

N 816 KTE

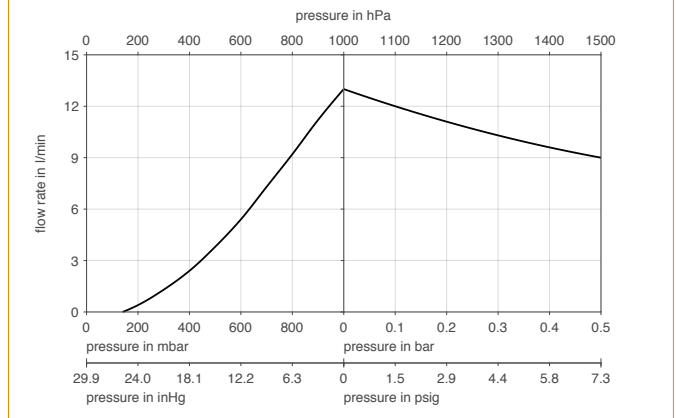

N 816 KNE | PUMP UP TIME FOR 5 LITER VESSEL

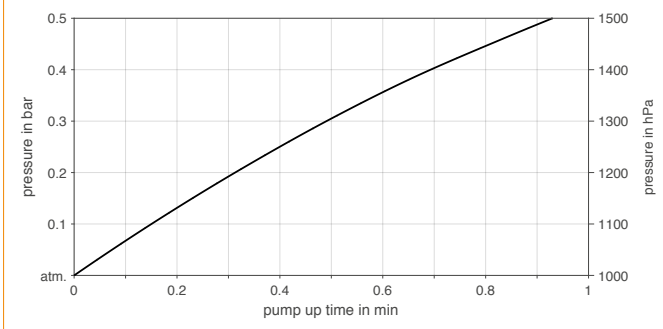

N 816 KTE | PUMP UP TIME FOR 5 LITER VESSEL

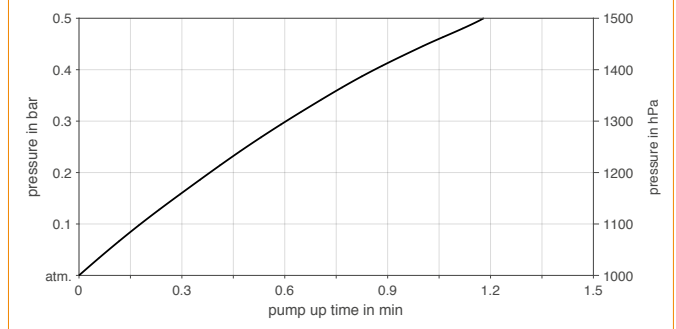

N 816 KNE | PUMP DOWN TIME FOR 5 LITER VESSEL

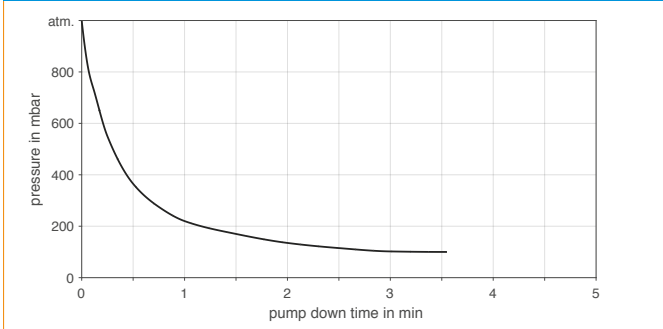

N 816 KTE | PUMP DOWN TIME FOR 5 LITER VESSEL

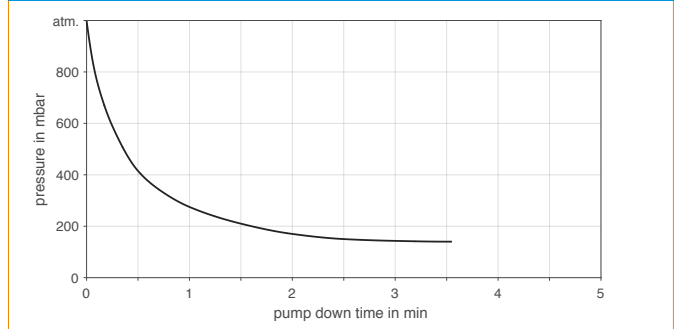

N 816 KNDC-B | KTDC-B

PERFORMANCE DATA

Series model	Flow rate at atm. pressure (l/min) ¹⁾	Max. operating pressure (bar rel./psig)	Ultimate vacuum (mbar abs.)
N 816 KNDC-B	16.0	0.5/7.3	100
N 816 KTDC-B	14.0	0.5/7.3	140

¹⁾ Liter at STP

N 816 K_DC-B

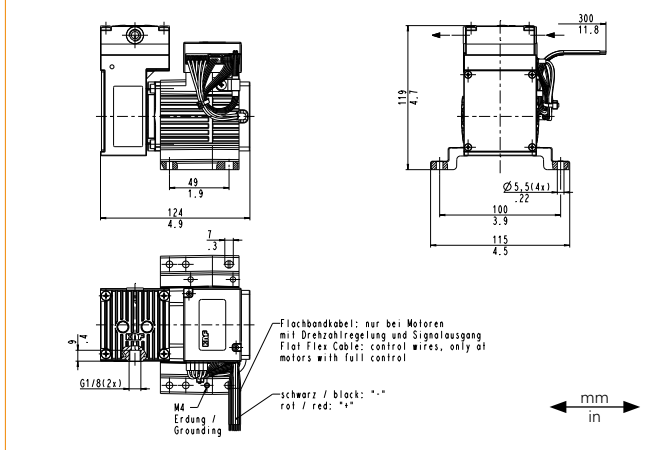

N 816 KNDC-B

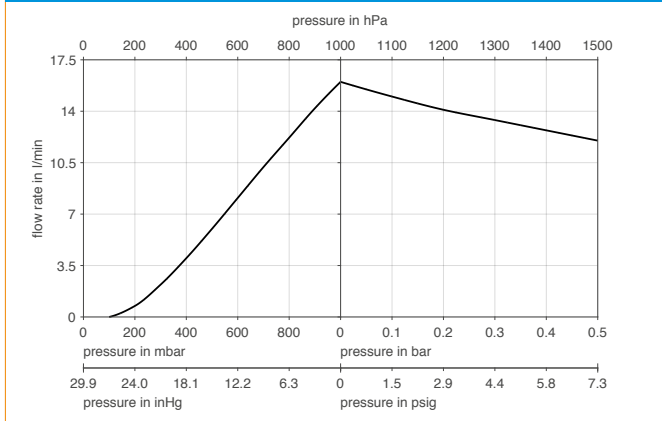

N 816 KTDC-B

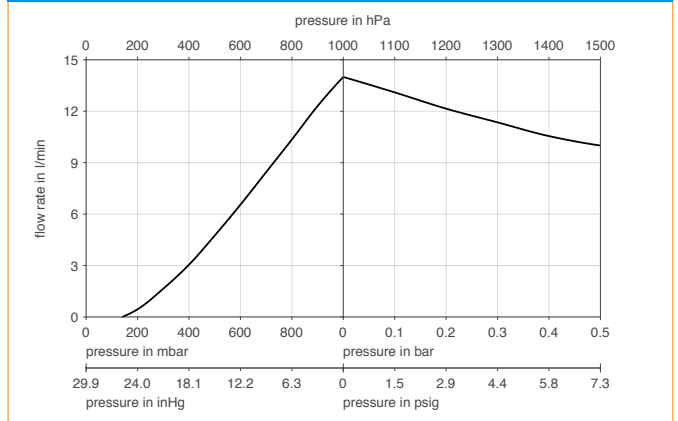

N 816 KNDC-B | PUMP UP TIME FOR 5 LITER VESSEL

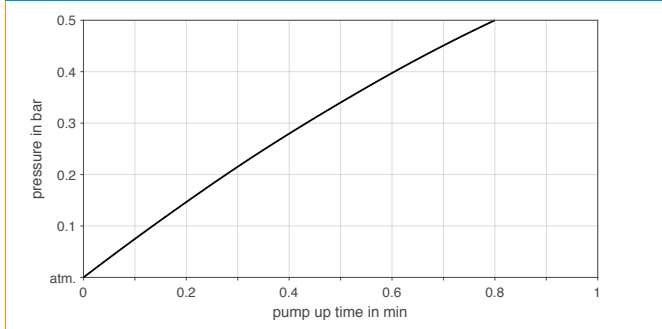

N 816 KTDC-B | PUMP UP TIME FOR 5 LITER VESSEL

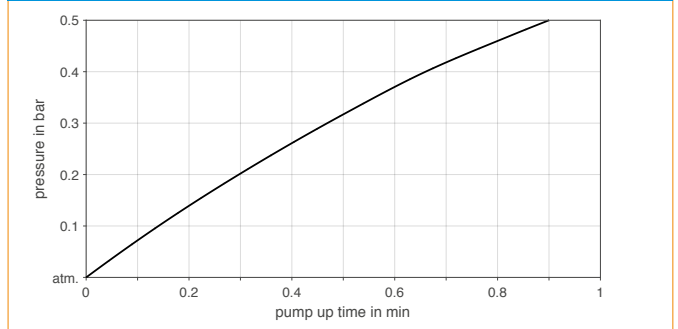

N 816 KNDC-B | PUMP DOWN TIME FOR 5 LITER VESSEL

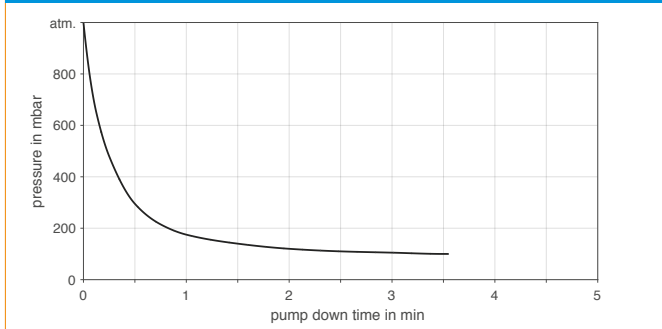

N 816 KTDC-B | PUMP DOWN TIME FOR 5 LITER VESSEL

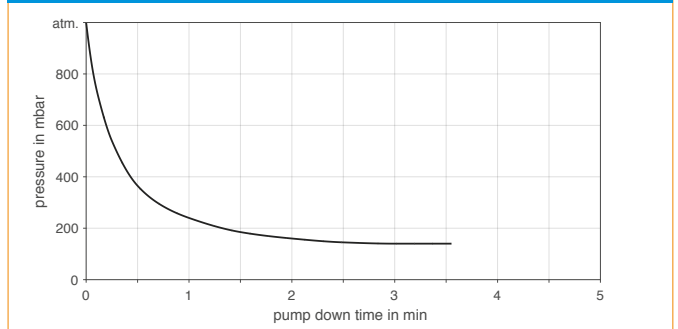

N 816 KN.29 DC-B | KT.29 DC-B

PERFORMANCE DATA

Series model	Flow rate at atm. pressure (l/min) ¹⁾	Max. operating pressure (bar rel./psig)	Ultimate vacuum (mbar abs.)
N 816 KN.29 DC-B	3.5–16.0	0.5/7.3	100
N 816 KT.29 DC-B	3.5–14.0	0.5/7.3	140

¹⁾ Liter at STP

N 816 K_29 DC-B

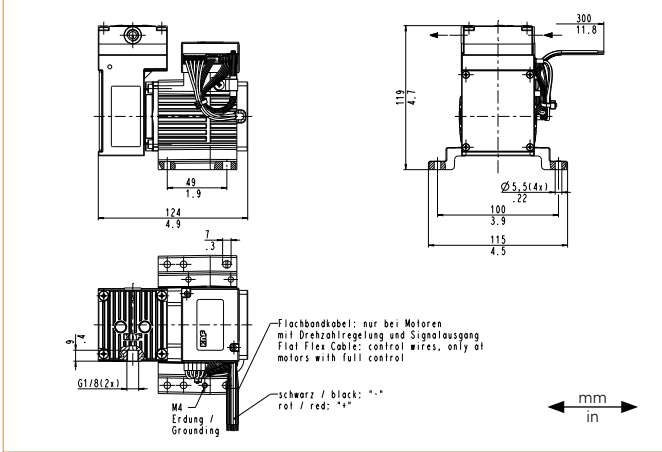

N 816 KN.29 DC-B

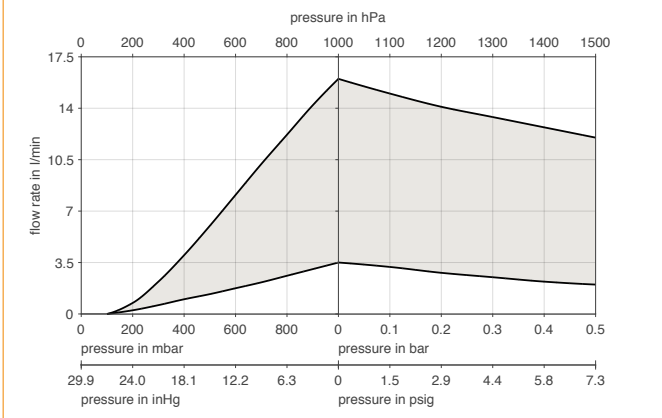

N 816 KT.29 DC-B

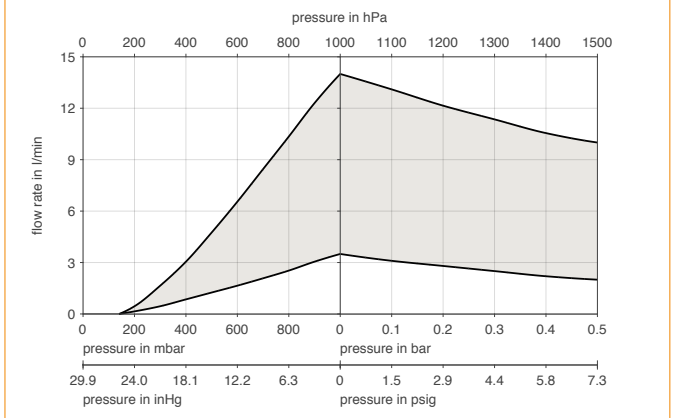

N 816 KN.29 DC-B | PUMP UP TIME FOR 5 LITER VESSEL

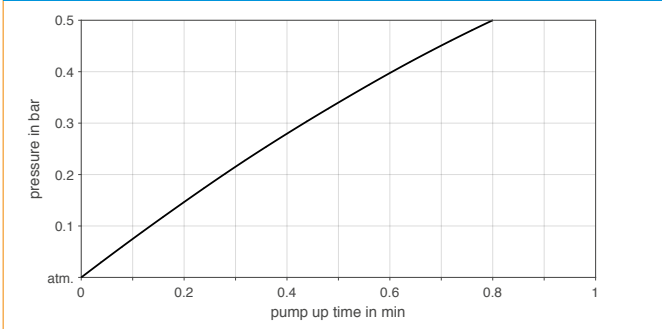

N 816 KT.29 DC-B | PUMP UP TIME FOR 5 LITER VESSEL

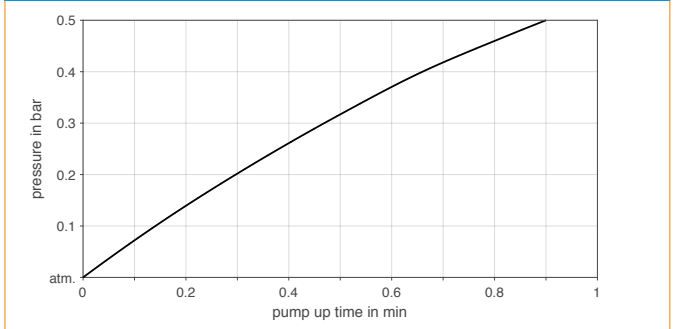

N 816 KN.29 DC-B | PUMP DOWN TIME FOR 5 LITER VESSEL

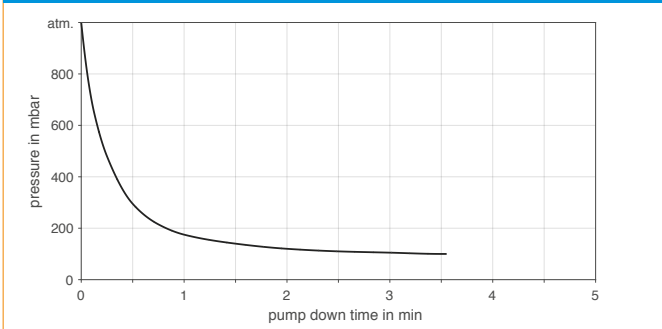

N 816 KT.29 DC-B | PUMP DOWN TIME FOR 5 LITER VESSEL

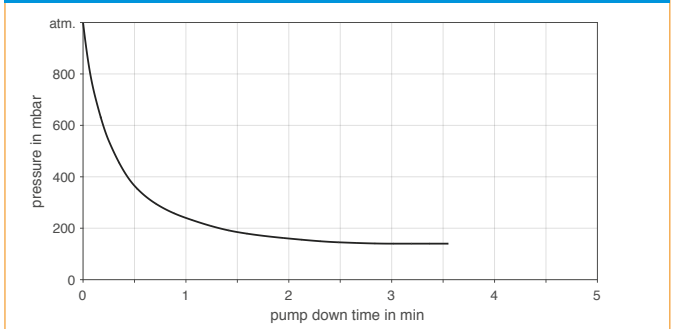

N 816 KN.29 DC-B-M | KT.29 DC-B-M

PERFORMANCE DATA

Series model	Flow rate at atm. pressure (l/min) ¹⁾	Max. operating pressure (bar rel./psig)	Ultimate vacuum (mbar abs.)
N 816 KN.29 DC-B-M	3.5–16.0	0.5/7.3	100
N 816 KT.29 DC-B-M	3.5–14.0	0.5/7.3	140

¹⁾ Liter at STP

N 816 K_29 DC-B-M

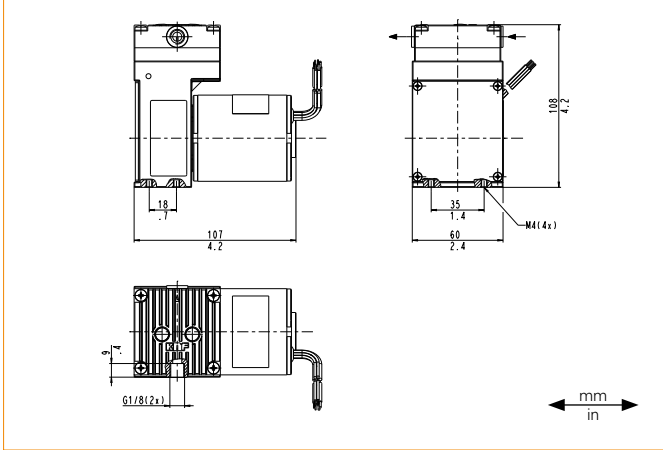

N 816 KN.29 DC-B-M

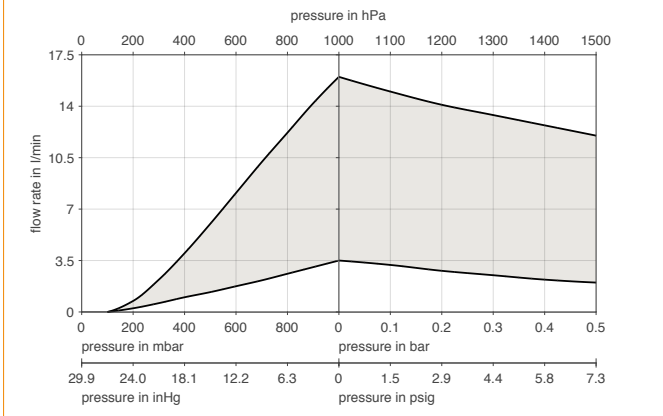

N 816 KT.29 DC-B-M

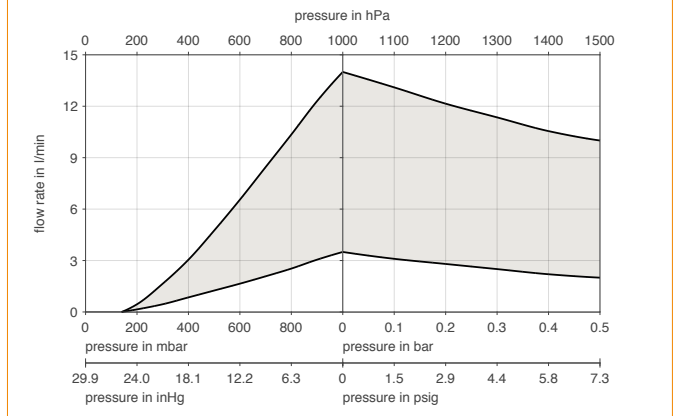

N 816 KN.29 DC-B-M | PUMP UP TIME FOR 5 LITER VESSEL

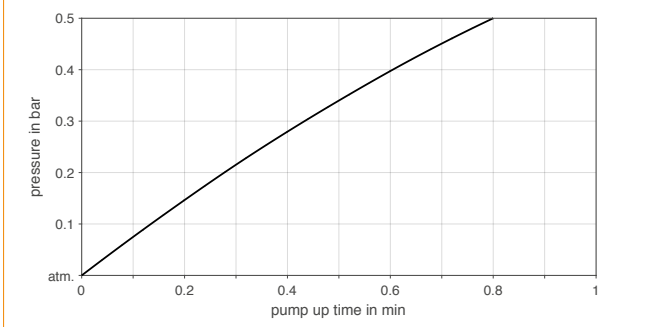

N 816 KT.29 DC-B-M | PUMP UP TIME FOR 5 LITER VESSEL

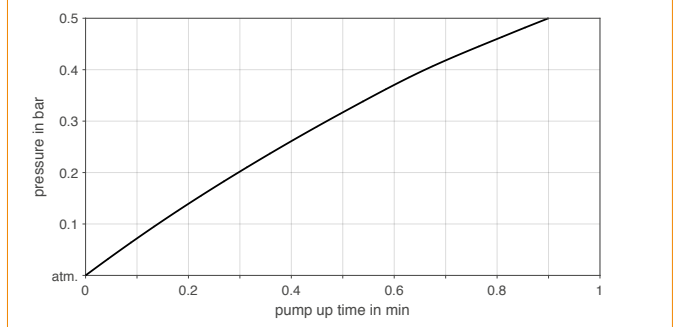

N 816 KN.29 DC-B-M | PUMP DOWN TIME FOR 5 LITER VESSEL

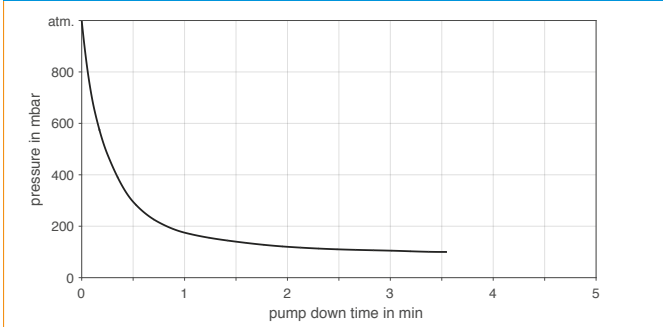

N 816 KT.29 DC-B-M | PUMP DOWN TIME FOR 5 LITER VESSEL

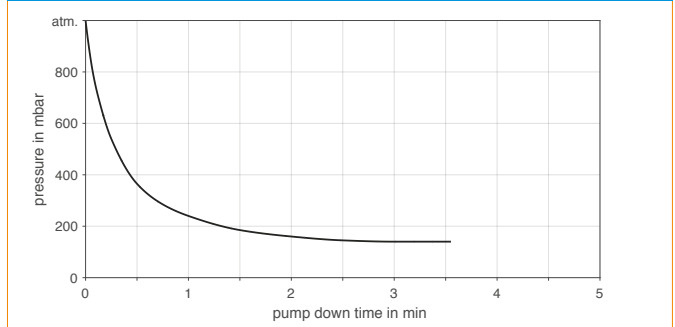

SPARE PARTS	
Description	Part No.
N 816 KN_	
Valve plate/sealing	059267
Diaphragm	052066
N 816 KT_	
Valve plate/sealing	057172
Diaphragm	044973

The performance values for the series models shown on this data sheet were determined under test conditions. The actual performance values may differ and depend in particular on the usage conditions and therefore on the specific application, on the parameters of the components involved in the user's system and on any technical modifications carried out which deviate from the standard configuration or the as delivered condition.

If individual designs have been created for specific customers on the basis of series models, other technical performance data may apply. Before operation begins, the relevant operating instructions and/or assembly or installation instructions should be read and the safety information contained in these instructions should be noted. KNF reserves the right to make changes to the product and the associated documentation without prior notice to the customer.



www.knf.com

YOUR LOCAL PARTNER AROUND THE WORLD

KNF SALES ORGANIZATION

Australia KNF Regional Office
Moreland West VIC 3055
Tel. +61 3 9386 4959
info@knf.com.au
www.knf.com.au

Benelux Netherlands KNF Verder B.V.
3451 GG Vleuten
Tel. +31 30 677 92 40
info@knf-verder.nl
www.knf-verder.nl

Benelux Belgium and Luxemburg
KNF Verder N.V.
2630 Aartselaar
Tel. +32 3 871 96 24
info@knf.be
www.knf.be

China KNF Technology (Shanghai) Co., Ltd.
Shanghai 201203
Tel. +86 21 5109 9695
info@knf.com.cn
www.knf.com.cn

France KNF Neuberger SAS
68128 Village-Neuf
Tel. +33 389 70 35 00
info@knf.fr
www.knf.fr

Germany KNF Neuberger GmbH
79112 Freiburg
Tel. +49 7664 5909 0
info@knf.de
www.knf.de

India KNF Pumps + Systems (India) Pvt. Ltd.
Hinjewadi Pune 411 057
Tel. +91 20 640 13 923
info@knfpumps.in
www.knfpumps.in

Italy KNF Italia S.r.l.
20063 Cernusco s. Naviglio (MI)
Tel. +39 02 929 04 91
info@knf.it
www.knf.it

Japan KNF Japan Co. Ltd.
Tokyo 104-0033
Tel. +81 3 3551 7931
info@knf.co.jp
www.knf.co.jp

Korea KNF Neuberger Ltd.
135-502 Seoul
Tel. +82 2 959 0255
knf@knfkorea.com
www.knfkorea.com

Latin America KNF Regional Office
Tel. +1 609 649 1010
gb@knf.com
www.knf.com/es

Morocco, Tunisia, Algeria
KNF Neuberger SAS
68128 Village-Neuf
Tel. +33 389 70 35 00
info@knf.fr
www.knf.fr

Singapore KNF Regional Office
Tel. +65 9722 1994
info@knf.com.sg
www.knf.com.sg

Sweden, Finland, Denmark, Norway
KNF Neuberger AB
117 43 Stockholm
Tel. +46 8 744 51 13
info@knf.se
www.knf.se

Switzerland KNF Neuberger AG
8362 Balzerswil
Tel. +41 71 973 99 30
knf@knf.ch
www.knf.ch

UK, Ireland KNF Neuberger U.K., Ltd.
Witney, Oxfordshire OX28 4FA
Tel. +44 1993 77 83 73
info@knf.co.uk
www.knf.co.uk

USA, Canada KNF Neuberger, Inc.
Trenton, NJ 08691-1810
Tel. +1 609 890 8600
knfusa@knf.com
www.knfusa.com

KNF PRODUCT CENTERS

Gas Pumps KNF Neuberger GmbH
DE-79112 Freiburg
info@knf.de
www.knf.de

Micro Gas Pumps KNF Micro AG
CH-6260 Reiden
info@knf-micro.ch
www.knf-micro.ch

Liquid Pumps KNF Flodos AG
CH-6210 Sursee
info@knf-flodos.ch
www.knf-flodos.ch